



EUREKA

Fliptop tables

The **Eureka** folding tables are the ideal solution for dynamic companies looking for versatile furniture. Designed to be handled by a single person, **Eureka** tables are ideal to quickly and easily set up a meeting room or temporary office. Quick and easy installation.



Meeting tables with mini Top Access hatch and optional modesty panel
Black - Nebraska



Meeting table with 2 straight tables and 2 half-moon tables
White - White



Video : How to create an opening in part drilled tops ?

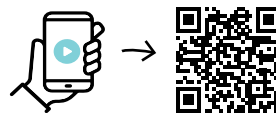

Scan the QR Code

U-shaped meeting table, with 3 straight tables, 1 integrated right corner table and 1 integrated left corner table
Black - Bleached Oak





Square meeting table with 2 straight tables, 2 integrated right corner tables and 2 integrated left corner tables
Black - Bleached Oak



Barrel meeting table with 2 curved intermediate tables and 2 trapezium end tables
Black - Bleached Oak



Diamond meeting table with 4 straight tables, 2 curved intermediate tables and 2 trapezium end tables
Black - Bleached Oak



V-shaped meeting table with 4 straight tables and 1 trapezium end table
Black - Bleached Oak

CONFIGURATIONS

How to create your own EUREKA meeting tables ?

SELECTION OF CONFIGURATIONS (DIM. IN CM)

Round table

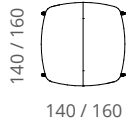

2 half-moon tables



Barrel table

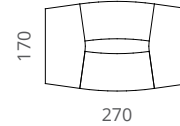

2 trapezium end tables
+
2 curved intermediate tables



Oval table

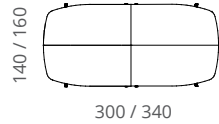

2 integrated right corner tables
+
2 integrated left corner tables

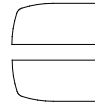

Oval table

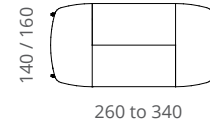

2 straight tables
+
2 half-moon tables

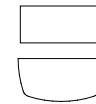

U-shaped table

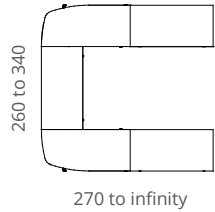

3 straight tables
+
1 integrated right corner table
+
1 integrated left corner table



U-shaped table

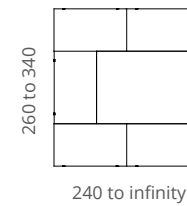

5 straight tables



Square table

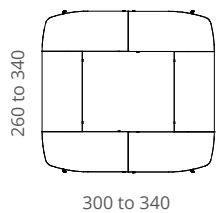

2 straight tables
+
2 integrated right corner tables
+
2 integrated left corner tables

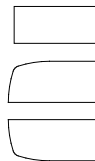

Rectangular table

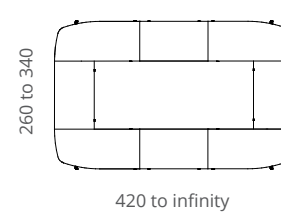

4 straight tables
+
2 integrated right corner tables
+
2 integrated left corner tables



V-shaped table

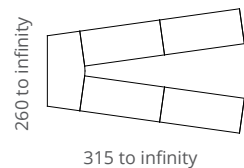

4 straight tables
+
1 trapezium end table

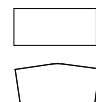

Diamond table

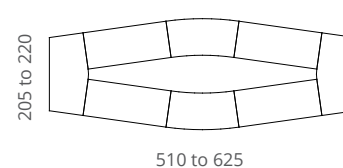

4 straight tables
+
2 trapezium end tables
+
2 curved intermediate tables



EUREKA Fliptop tables

WARRANTY
10
YEARS

Electrification

2 round part drilled cable ports and 1 rectangular part drilled cable port in the centre for single Top Access hatch under the tops.



Top

25 mm thick Structurex® melamine-coated top. 2 mm thick shock-proof ABS edging.

Handles

Locking / unlocking handles located under the tops.

Connectors

4 black connectors included per table.

Leg

Metal structure composed of 2 legs (1 column of rectangular cross-section 70 x 30 mm and steel plate base 45 x 5 mm) and Ø 75 mm lockable castors.



Handles locking / unlocking the tops



Optional Mini Top Access hatch

TECHNICAL DESCRIPTION

- Tops made of 25 mm thick Structurex® melamine-coated panels. 2 mm thick shock-proof ABS edging.
- Cable management : 2 round part drilled cable ports and 1 rectangular part drilled cable port in the centre for mini Top Access hatch under the tops.
- Metal structure composed of 2 legs (1 column of rectangular cross-section 70 x 30 mm and steel plate base 45 x 5 mm) and Ø 75 mm lockable castors. The assembly is connected by a central extendable steel beam for perfect stability, lacquered epoxy finish.
- The tops are extremely easy to tilt using the locking/unlocking handles.
- The vertical and horizontal positions are secured by a locking system which is unlocked by using the handles. The L 180 cm tables are also equipped with a metal bar on the front of the top.
- The tilting system with pivoting axes is welded to the beam and screwed under the top.
- 4 black connectors included for each table, to join tables together perfectly side by side.
- Suspended modesty panels available on option made of 16 mm thick Structurex® melamine-coated panels with 2 mm thick shock-proof ABS edging.
- The tables are stored by nesting the legs together in order to save space : 19,5 cm per extra table in depth in addition to the size of the 1st folded table (D 60 / D 70 cm).



CHARACTERISTICS



Metal legs finishes



Tops and modesty panels MFC finishes

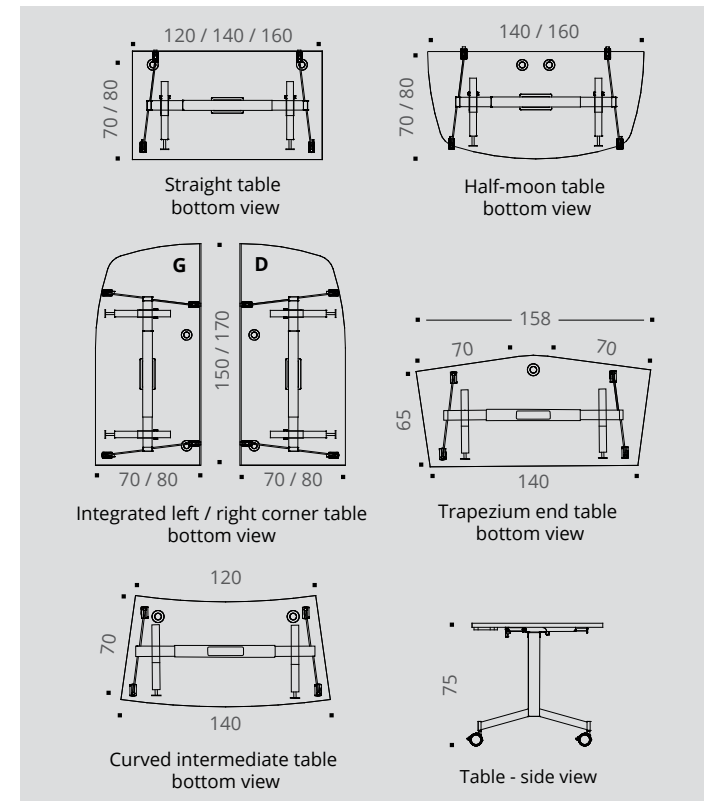

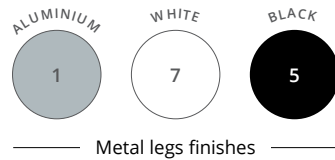

Fliptop STRAIGHT TABLES

Tops equipped with part drilled openings for optional Ø 80 mm cable ports and mini Top Access hatch



	Dim. (cm)	Ref.	Leg finish	Top finish	Ref.	Leg finish	Top finish
Straight tables H 75 cm Kit of 4 connectors included On Ø 75 mm lockable castors	L 120	DN40	+ <input type="checkbox"/>	+ <input type="checkbox"/>	DH70	+ <input type="checkbox"/>	+ <input type="checkbox"/>
	L 140	DN41	+ <input type="checkbox"/>	+ <input type="checkbox"/>	DH71	+ <input type="checkbox"/>	+ <input type="checkbox"/>
	L 160	DN42	+ <input type="checkbox"/>	+ <input type="checkbox"/>	DH72	+ <input type="checkbox"/>	+ <input type="checkbox"/>
	L 180	DZ17	+ <input type="checkbox"/>	+ <input type="checkbox"/>	DZ18	+ <input type="checkbox"/>	+ <input type="checkbox"/>
		NEW					



Fliptop HALF-MOON TABLES

Tops equipped with part drilled openings for optional Ø 80 mm cable ports and mini Top Access hatch

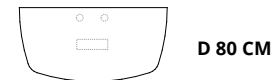
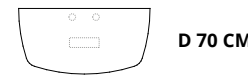

	Dim. (cm)	Ref.	Leg finish	Top finish	Ref.	Leg finish	Top finish
Half-moon tables H 75 cm Kit of 4 connectors included On Ø 75 mm lockable castors	L 140 / 120 structure	DN43	+ <input type="checkbox"/>	+ <input type="checkbox"/>	—	—	—
	L 160 / 140 structure	—	—	—	DN44	+ <input type="checkbox"/>	+ <input type="checkbox"/>

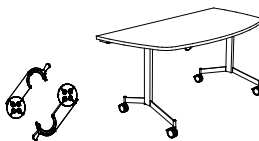

How to order ? L 140 / D 80 cm fliptop straight table, **Black** metal leg, **Bleached Oak** top MFC finish = DH71 + 5 N



Fliptop INTEGRATED CORNER TABLES

Tops equipped with part drilled openings for optional Ø 80 mm cable ports and mini Top Access hatch

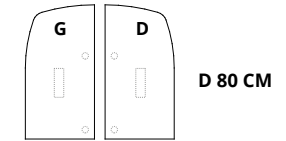
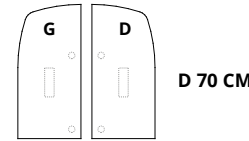

	Description	Dim. (cm)	Ref.	Leg finish	Top finish	Ref.	Leg finish	Top finish
Integrated corner tables H 75 cm Kit of 4 connectors included On Ø 75 mm lockable castors	Left corner	L 150 / 120 structure	DN46	+ <input type="checkbox"/>	+ <input type="checkbox"/>	—	—	—
	Right corner	L 150 / 120 structure	DN45	+ <input type="checkbox"/>	+ <input type="checkbox"/>	—	—	—
	Left corner	L 170 / 140 structure	—	—	—	DN48	+ <input type="checkbox"/>	+ <input type="checkbox"/>
	Right corner	L 170 / 140 structure	—	—	—	DN47	+ <input type="checkbox"/>	+ <input type="checkbox"/>

Fliptop TRAPEZIUM END TABLES

Tops equipped with part drilled opening for optional Ø 80 mm cable port



	Description	Dim. (cm)	Ref.	Leg finish	Top finish
Trapezium end table H 75 cm Kit of 4 connectors included On Ø 75 mm lockable castors	Only for configurations with tables D 70 cm	L 158 / 140 structure	DZ19	+ <input type="checkbox"/>	+ <input type="checkbox"/>

Fliptop CURVED INTERMEDIATE TABLES

Tops equipped with part drilled openings for optional Ø 80 mm cable port



	Description	Dim. (cm)	Ref.	Leg finish	Top finish
Curved intermediate table H 75 cm Kit of 4 connectors included On Ø 75 mm lockable castors	Only for configurations with tables D 70 cm	L 140 / 140 structure	DZ20	+ <input type="checkbox"/>	+ <input type="checkbox"/>



MEETING

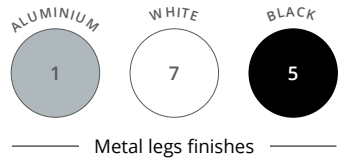













► Options



Structurex® modesty panels
H 28 cm
H 35 cm table-mounted



Description	● ALUMINIUM BRACKETS		○ WHITE BRACKETS		● BLACK BRACKETS	
	Ref.	Finish	Ref.	Finish	Ref.	Finish
For table						
L 120	BY371	+ 	BY377	+ 	BY375	+ 
L 140	BY381	+ 	BY387	+ 	BY385	+ 
L 160	BY391	+ 	BY397	+ 	BY395	+ 
L 180	DZ211	+ 	DZ217	+ 	DZ215	+ 

UK single cable port power module
UK power socket + 1 USB A socket 5v
With a 2 m power supply cable



Fitted into the Ø 80 mm part drilled cable port of table

Ø 100 mm

Description	Dim. (cm)	○ WHITE	● BLACK
		Ref.	Ref.
		DR997S	DR995G

UK cable port power module
UK power socket + 1 USB A socket 5v
+ 1 USB C socket 5v
With a 2 m power supply cable



Fitted into the Ø 80 mm part drilled cable port of table

Ø 91 mm

DX877S

DX875G

Description	● ALUMINIUM		○ WHITE		● BLACK	
	Ref.	Ref.	Ref.	Ref.	Ref.	Ref.
Mini Top Access hatch Metal, to be fitted onto the tops (part drilled Top Access hatch), allows for central cables management. Dim. 24 x 12 cm	DP071K	DP077S	DP075G			

except trapezium and curved tables