



ASTRO

With their clean and elegant design, Astro desks are ideal to meet the requirements of individual or shared workspaces.

With an elegant arched framework and a “floating” worktop effect, it is the ideal choice for open offices where space usage needs to be optimised. With a range of accessories and cable management options **Astro** can be adapted and upgraded to meet changing office requirements.





Multi-workstations on B-box consoles

White - Bleached Oak - Bleached Oak Console B-box

Top heightening spacers



Multi-workstations
Aluminium - Nebraska



Electrification

Top fitted with \varnothing 80 mm cable ports, a single Top Access hatch or a 2 cm deep scallop, depending on version.

Top

25 mm thick Structurex® melamine-coated tops. 2 mm thick shock-proof ABS edging.



Top spacers

Top heightening spacers

Multi-workstation

Leg

Metal arch structure leg configuration, 70 x 30 mm, available in single workstation and/or double arch for shared workstation, with recessed add-on leg for add-on units, lacquered epoxy finish.

TECHNICAL DESCRIPTION

- 25 mm thick Structurex® melamine-coated tops.
- 2 mm thick shock-proof ABS edging.
- Tops fitted with \varnothing 80 mm cable ports, a single Top Access hatch (internal dimensions L 30,9 / D 11,6 cm) finishes matching the legs or a 2 cm deep scallop to feed cables, depending on version.
- Metal arch legs in lacquered epoxy finish, cross-section 70 x 30 mm, available in single version or double arch version for shared workstation, with recessed arch leg on add-on units to move easily from one desk to another.
- Adjustable screw feet of diameter 30 mm and range 10 mm to compensate for any unevenness in the floor.
- In back-to-back configuration, a 3 cm gap is provided between the tops for a screen divider or to feed cables.
- Single or multi-workstation desks available with B-box return console (dim. L 180 / D 60 / H 59,5 cm). The B-box console, which can be positioned on the right or left of the desks, consists of 2 compartments L 56 / D 56 cm and 2 compartments L 29 / D 56 / H 50 cm.
- Optionally, the B-box console can be equipped with 1 hinged door, 1 sliding door or 1 drawer for lateral filing.

CHARACTERISTICS



Metal legs finishes

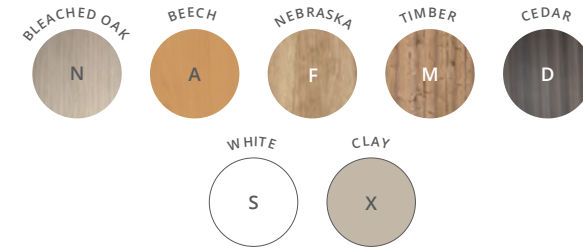

Tops and B-box console MFC finishes

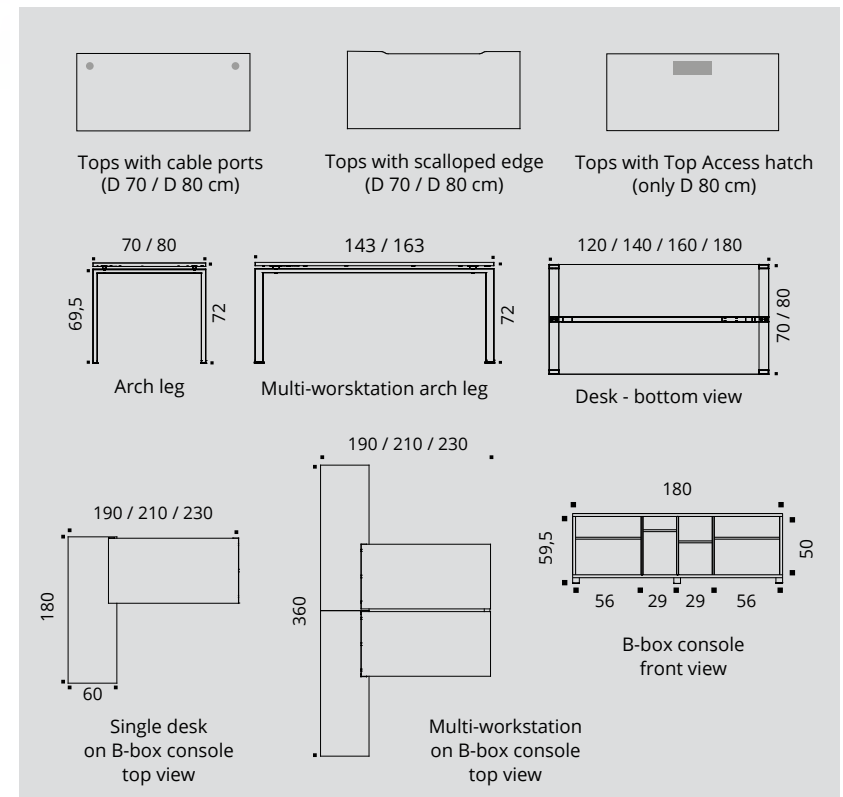

Tops with cable ports (D 70 / D 80 cm)

Tops with scalloped edge (D 70 / D 80 cm)

Tops with Top Access hatch (only D 80 cm)

Arch leg

Multi-workstation arch leg

Desk - bottom view

Single desk on B-box console top view

Multi-workstation on B-box console top view

B-box console front view



Single desk with return
Black - Nebraska

Single desk with return
Aluminium - White





Metal legs finishes



Tops MFC finishes

SINGLE DESKS with cable ports



D 70 CM

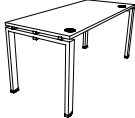

D 80 CM

| | Dim. (cm) | Ref. | Leg finish | Top finish | Ref. | Leg finish | Top finish |
|---|-----------|------|----------------------------|----------------------------|------|----------------------------|----------------------------|
| Straight desks H 72 cm  | L 120 | BK64 | + <input type="checkbox"/> | + <input type="checkbox"/> | BU58 | + <input type="checkbox"/> | + <input type="checkbox"/> |
| | L 140 | BK65 | + <input type="checkbox"/> | + <input type="checkbox"/> | BP16 | + <input type="checkbox"/> | + <input type="checkbox"/> |
| | L 160 | BT27 | + <input type="checkbox"/> | + <input type="checkbox"/> | BN09 | + <input type="checkbox"/> | + <input type="checkbox"/> |
| | L 180 | — | — | — | BN10 | + <input type="checkbox"/> | + <input type="checkbox"/> |

| | Dim. (cm) | Ref. | Leg finish | Top finish |
|--|--------------|------|----------------------------|----------------------------|
| Extension / Return On arch leg H 72 cm  | D 60 / L 80 | DW59 | + <input type="checkbox"/> | + <input type="checkbox"/> |
| | D 60 / L 100 | DW88 | + <input type="checkbox"/> | + <input type="checkbox"/> |

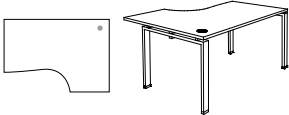
| | Dim. (cm) | Ref. | Leg finish | Top finish |
|--|-------------------------|------|----------------------------|----------------------------|
| Compact desks D 80 to 110 / H 72 cm D 60 cm return  | L 160 right hand return | BP27 | + <input type="checkbox"/> | + <input type="checkbox"/> |
| | L 160 left hand return | BP28 | + <input type="checkbox"/> | + <input type="checkbox"/> |
| | L 180 right hand return | BP29 | + <input type="checkbox"/> | + <input type="checkbox"/> |
| | L 180 left hand return | BP30 | + <input type="checkbox"/> | + <input type="checkbox"/> |

► Options

Technical metal cable trays
D 16 / H 8 cm
Internal H 4 cm

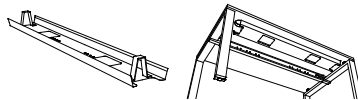

| Dim. (cm) | ALUMINIUM | WHITE | BLACK |
|----------------------|-----------|--------|--------|
| | Ref. | Ref. | Ref. |
| L 90 for L 120 desk | AZ201K | AZ207S | AZ205G |
| L 110 for L 140 desk | AZ211K | AZ217S | AZ215G |
| L 130 for L 160 desk | AZ221K | AZ227S | AZ225G |
| L 150 for L 180 desk | AZ231K | AZ237S | AZ235G |



Cable port covers are included, colour matches the legs

COLLABORATIVE DESKS

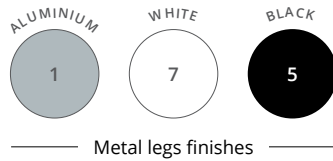

ASTRO



SINGLE DESKS

with cable ports on B-box console

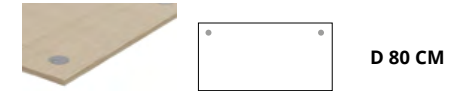

| | | Main station dim. (cm) | Total dim. (cm) | Ref. | Leg finish | Top and B-box finish |
|---|--|------------------------|-----------------|------|----------------------------|----------------------------|
| Straight desks D 80 cm on B-box console H 72 cm The B-box console can be positioned on the right or the left | | D 80 / L 140 | D 180 / L 190 | DW32 | + <input type="checkbox"/> | + <input type="checkbox"/> |
| | | D 80 / L 160 | D 180 / L 210 | DW33 | + <input type="checkbox"/> | + <input type="checkbox"/> |
| | | D 80 / L 180 | D 180 / L 230 | DW34 | + <input type="checkbox"/> | + <input type="checkbox"/> |
| 2 Straight desks D 80 cm in staggered configuration on shared B-box console H 72 cm | | D 80 / L 140 | D 180 / L 320 | DW35 | + <input type="checkbox"/> | + <input type="checkbox"/> |
| | | D 80 / L 160 | D 180 / L 360 | DW36 | + <input type="checkbox"/> | + <input type="checkbox"/> |
| | | D 80 / L 180 | D 180 / L 400 | DW37 | + <input type="checkbox"/> | + <input type="checkbox"/> |

► B-box options



| | | Ref. | Finish |
|--|--|--------|----------------------------|
| Hinged door (to be fitted on the right or the left) | | DF843 | + <input type="checkbox"/> |
| Sliding door (to be fitted on the right or the left) | | DF853 | + <input type="checkbox"/> |
| Drawer unit for lateral filing* (front included) * Not compatible with hinged door | | BX163 | + <input type="checkbox"/> |
| Sliding pen tray | | BF901K | Grey |

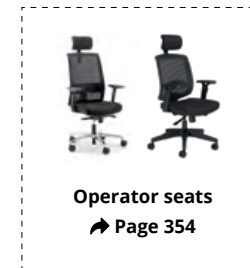

COLLABORATIVE DESKS

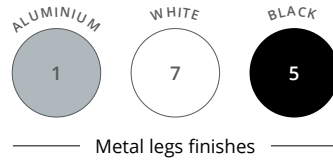

SINGLE DESKS with scalloped edge

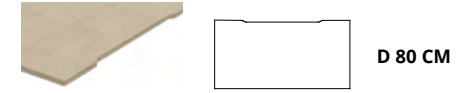
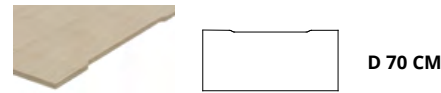

| | Dim. (cm) | Ref. | Leg finish | Top finish | Ref. | Leg finish | Top finish |
|----------------------------------|-----------|------|----------------------------|----------------------------|------|----------------------------|----------------------------|
| Straight desks H 72 cm | L 120 | DP39 | + <input type="checkbox"/> | + <input type="checkbox"/> | DP42 | + <input type="checkbox"/> | + <input type="checkbox"/> |
| | L 140 | DP40 | + <input type="checkbox"/> | + <input type="checkbox"/> | DP43 | + <input type="checkbox"/> | + <input type="checkbox"/> |
| | L 160 | DP41 | + <input type="checkbox"/> | + <input type="checkbox"/> | DP44 | + <input type="checkbox"/> | + <input type="checkbox"/> |
| | L 180 | — | — | — | DP45 | + <input type="checkbox"/> | + <input type="checkbox"/> |

| | Dim. (cm) | Ref. | Leg finish | Top finish |
|---|--------------|------|----------------------------|----------------------------|
| Extension / Return On arch leg H 72 cm | D 60 / L 80 | DW59 | + <input type="checkbox"/> | + <input type="checkbox"/> |
| | D 60 / L 100 | DW88 | + <input type="checkbox"/> | + <input type="checkbox"/> |

► Options

Technical metal cable trays
D 16 / H 8 cm
Internal H 4 cm

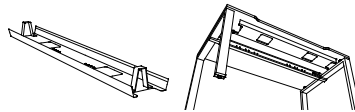

| Dim. (cm) | ALUMINIUM | WHITE | BLACK |
|----------------------|-----------|--------|--------|
| | Ref. | Ref. | Ref. |
| L 90 for L 120 desk | AZ201K | AZ207S | AZ205G |
| L 110 for L 140 desk | AZ211K | AZ217S | AZ215G |
| L 130 for L 160 desk | AZ221K | AZ227S | AZ225G |
| L 150 for L 180 desk | AZ231K | AZ237S | AZ235G |



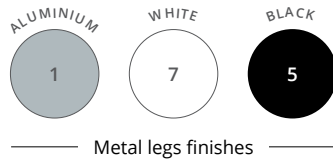

ASTRO



SINGLE DESKS

with scalloped edge on B-box consoles

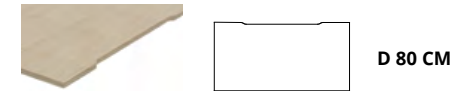

| | Main station dim. (cm) | Total dim. (cm) | Ref. | Leg finish | Top and B-box finish |
|---|------------------------|-----------------|------|------------|----------------------|
| Straight desks D 80 cm on B-box console H 72 cm The B-box console can be positioned on the right or the left | D 80 / L 140 | D 180 / L 190 | DW41 | + | + |
| | D 80 / L 160 | D 180 / L 210 | DW42 | + | + |
| | D 80 / L 180 | D 180 / L 230 | DW43 | + | + |
| 2 Straight desks D 80 cm in staggered configuration on shared B-box console H 72 cm | D 80 / L 140 | D 180 / L 320 | DW44 | + | + |
| | D 80 / L 160 | D 180 / L 360 | DW45 | + | + |
| | D 80 / L 180 | D 180 / L 400 | DW46 | + | + |

► B-box options



| | Ref. | Finish |
|---|--------|--------|
| Hinged door (to be fitted on the right or the left) | DF843 | + |
| Sliding door (to be fitted on the right or the left) | DF853 | + |
| Drawer unit for lateral filing* (front included) <small>* Not compatible with hinged door</small> | BX163 | + |
| Sliding pen tray | BF901K | Grey |



How to order ? 2 straight desks in staggered configuration on shared B-box console, D 80 / L 180 cm, **White** metal leg, **Clay** top and B-box MFC finish = DW46 + 7 X

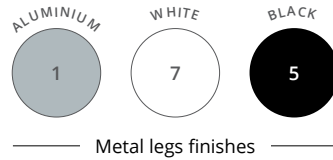

SINGLE DESKS
with Top Access hatch

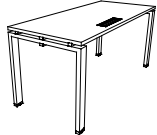

| | Dim. (cm) | Ref. | Leg finish | Top finish |
|---|-----------|------|----------------------------|----------------------------|
| Straight desks H 72 cm  | L 120 | DE43 | + <input type="checkbox"/> | + <input type="checkbox"/> |
| | L 140 | DE44 | + <input type="checkbox"/> | + <input type="checkbox"/> |
| | L 160 | DE45 | + <input type="checkbox"/> | + <input type="checkbox"/> |
| | L 180 | DE46 | + <input type="checkbox"/> | + <input type="checkbox"/> |

| | | | | |
|--|--------------|------|----------------------------|----------------------------|
| Extension / Return On arch leg H 72 cm  | D 60 / L 80 | DW59 | + <input type="checkbox"/> | + <input type="checkbox"/> |
| | D 60 / L 100 | DW88 | + <input type="checkbox"/> | + <input type="checkbox"/> |

► **Options**

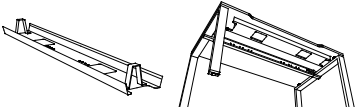
| | Dim. (cm) | <input type="radio"/> ALUMINIUM Ref. | <input type="radio"/> WHITE Ref. | <input type="radio"/> BLACK Ref. |
|---|----------------------|---|-------------------------------------|-------------------------------------|
| Technical metal cable trays D 16 / H 8 cm Internal H 4 cm  | L 90 for L 120 desk | AZ201K | AZ207S | AZ205G |
| | L 110 for L 140 desk | AZ211K | AZ217S | AZ215G |
| | L 130 for L 160 desk | AZ221K | AZ227S | AZ225G |
| | L 150 for L 180 desk | AZ231K | AZ237S | AZ235G |



COLLABORATIVE DESKS

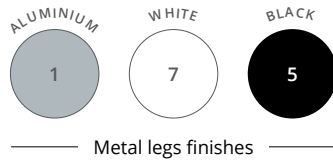

ASTRO



SINGLE DESKS

with Top Access hatch on B-box console



| | | Main station dim. (cm) | Total dim. (cm) | Ref. | Leg finish | Top and B-box finish |
|---|--|------------------------|-----------------|------|----------------------------|----------------------------|
| Straight desks D 80 cm on B-box console H 72 cm The B-box console can be positioned on the right or the left | | D 80 / L 140 | D 180 / L 190 | DW50 | + <input type="checkbox"/> | + <input type="checkbox"/> |
| | | D 80 / L 160 | D 180 / L 210 | DW51 | + <input type="checkbox"/> | + <input type="checkbox"/> |
| | | D 80 / L 180 | D 180 / L 230 | DW52 | + <input type="checkbox"/> | + <input type="checkbox"/> |
| 2 Straight desks D 80 cm in staggered configuration on shared B-box console H 72 cm | | D 80 / L 140 | D 180 / L 320 | DW53 | + <input type="checkbox"/> | + <input type="checkbox"/> |
| | | D 80 / L 160 | D 180 / L 360 | DW54 | + <input type="checkbox"/> | + <input type="checkbox"/> |
| | | D 80 / L 180 | D 180 / L 400 | DW55 | + <input type="checkbox"/> | + <input type="checkbox"/> |

► B-box options



| | | Ref. | Finish |
|---|--|--------|----------------------------|
| Hinged door (to be fitted on the right or the left) | | DF843 | + <input type="checkbox"/> |
| Sliding door (to be fitted on the right or the left) | | DF853 | + <input type="checkbox"/> |
| Drawer unit for lateral filing* (front included) <small>* Not compatible with hinged door</small> | | BX163 | + <input type="checkbox"/> |
| Sliding pen tray | | BF901K | Grey |

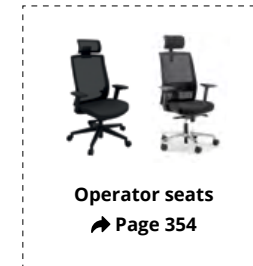



Multi-workstations
Aluminium - White

Multi-workstations
Black - Nebraska



COLLABORATIVE DESKS



Multi-workstations on B-box consoles
White - Bleached Oak - Bleached Oak B-box console

Multi-workstations with scalloped edge
Black - Clay



COLLABORATIVE DESKS

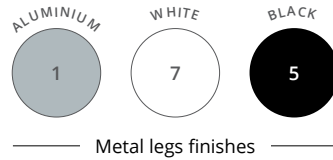

MULTI-WORKSTATIONS with cable-ports

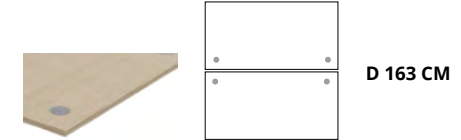
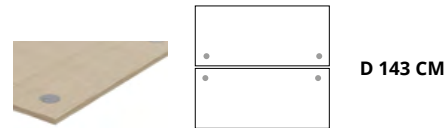

| | | Dim. (cm) | Ref. | Leg finish | Top finish | | Ref. | Leg finish | Top finish |
|---|--|-----------|------|----------------------------|----------------------------|--|------|----------------------------|----------------------------|
| 2 back to back desks Starter unit H 72 cm | | L 120 | BQ98 | + <input type="checkbox"/> | + <input type="checkbox"/> | | BP17 | + <input type="checkbox"/> | + <input type="checkbox"/> |
| | | L 140 | BR00 | + <input type="checkbox"/> | + <input type="checkbox"/> | | BU67 | + <input type="checkbox"/> | + <input type="checkbox"/> |
| | | L 160 | BR42 | + <input type="checkbox"/> | + <input type="checkbox"/> | | BP18 | + <input type="checkbox"/> | + <input type="checkbox"/> |
| | | L 180 | — | — | — | | BP19 | + <input type="checkbox"/> | + <input type="checkbox"/> |
| 2 back to back desks Add-on unit H 72 cm | | L 120 | BQ99 | + <input type="checkbox"/> | + <input type="checkbox"/> | | BU68 | + <input type="checkbox"/> | + <input type="checkbox"/> |
| | | L 140 | BR01 | + <input type="checkbox"/> | + <input type="checkbox"/> | | BU69 | + <input type="checkbox"/> | + <input type="checkbox"/> |
| | | L 160 | BR43 | + <input type="checkbox"/> | + <input type="checkbox"/> | | BU70 | + <input type="checkbox"/> | + <input type="checkbox"/> |
| | | L 180 | — | — | — | | BU71 | + <input type="checkbox"/> | + <input type="checkbox"/> |

► Options

Double metal cable trays
D 33,5 / H 9 cm
Internal H 4,5 cm

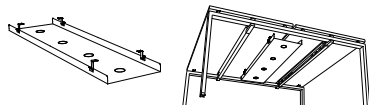

Dim. (cm)

L 75 for L 120 desk
L 95 for L 140 desk
L 115 for L 160 desk
L 135 for L 180 desk

● BLACK

Ref.

DZ135G
DW765G
DW775G
DW785G

Cable port covers are included, colour matches the legs

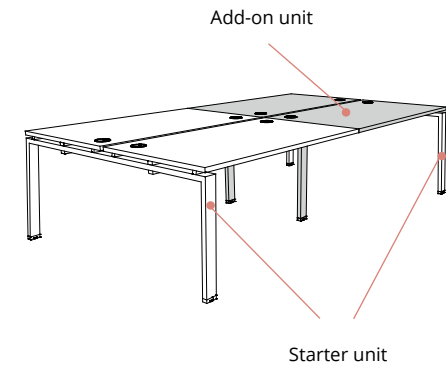

Starter unit

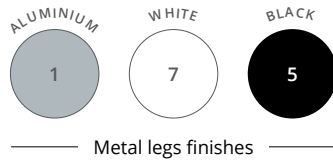

ASTRO



MULTI-WORKSTATIONS with cable ports on B-box consoles

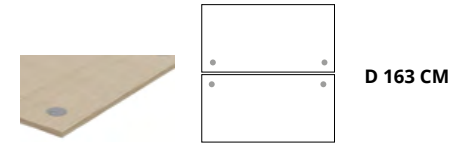

| | Main station dim. (cm) | Total dim. (cm) | Ref. | Leg finish | Top and B-box finish |
|---|------------------------|-----------------|------|------------|----------------------|
| 2 back to back desks D 80 cm on 2 B-box consoles H 72 cm | D 163 / L 140 | D 360 / L 190 | DW38 | + | + |
| | D 163 / L 160 | D 360 / L 210 | DW39 | + | + |
| | D 163 / L 180 | D 360 / L 230 | DW40 | + | + |

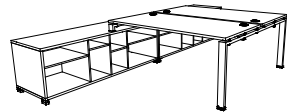

► B-box options



| | Ref. | Finish |
|---|--------|--------|
| Hinged door (to be fitted on the right or the left) | DF843 | + |
| Sliding door (to be fitted on the right or the left) | DF853 | + |
| Drawer unit for lateral filing* (front included) <small>* Not compatible with hinged door</small> | BX163 | + |
| Sliding pen tray | BF901K | Grey |

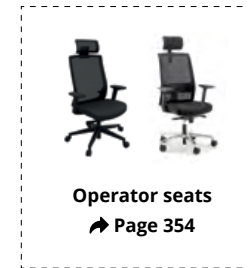
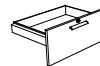
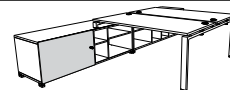
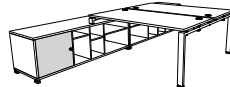

Cable port covers are included, colour matches the legs

How to order ? 2 back to back desks on 2 B-box consoles, L 140 cm, **White** metal leg, **Bleached Oak** top and B-box MFC finish = DW38 +

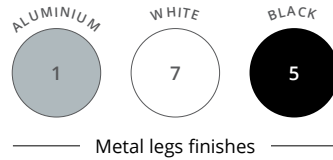

MULTI-WORKSTATIONS with scalloped edge

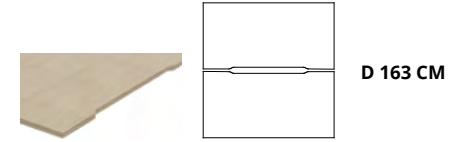
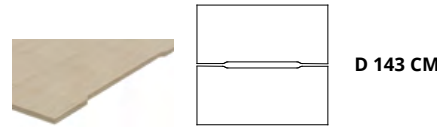

| | | Dim. (cm) | Ref. | Leg finish | Top finish | | Ref. | Leg finish | Top finish |
|---|--|-----------|------|------------|------------|--|------|------------|------------|
| 2 back to back desks Starter unit H 72 cm | | L 120 | BK69 | + [] | + [] | | BR46 | + [] | + [] |
| | | L 140 | BK70 | + [] | + [] | | BR48 | + [] | + [] |
| | | L 160 | BR44 | + [] | + [] | | BK75 | + [] | + [] |
| | | L 180 | — | — | — | | BK76 | + [] | + [] |
| | | | | | | | | | |
| 2 back to back desks Add-on unit H 72 cm | | L 120 | BK71 | + [] | + [] | | BR47 | + [] | + [] |
| | | L 140 | BK72 | + [] | + [] | | BR49 | + [] | + [] |
| | | L 160 | BR45 | + [] | + [] | | BK77 | + [] | + [] |
| | | L 180 | — | — | — | | BK78 | + [] | + [] |
| | | | | | | | | | |

COLLABORATIVE DESKS

Options

Double metal cable trays
D 33,5 / H 9 cm
Internal H 4,5 cm

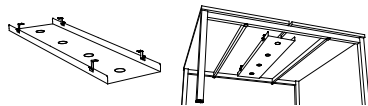

Dim. (cm)

L 75 for L 120 desk
L 95 for L 140 desk
L 115 for L 160 desk
L 135 for L 180 desk

● **BLACK**

Ref.

DZ135G
DW765G
DW775G
DW785G

Add-on unit

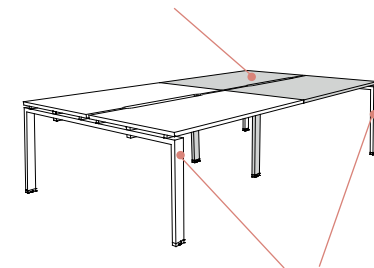

Starter unit

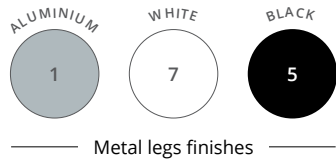

ASTRO



MULTI-WORKSTATIONS

with scalloped edge on B-box consoles

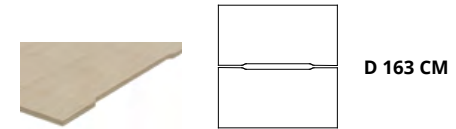

| | Main station dim. (cm) | Total dim. (cm) | Ref. | Leg finish | Top and B-box finish |
|---|------------------------|-----------------|------|------------|----------------------|
| 2 back to back desks D 80 cm on 2 B-box consoles H 72 cm | D 163 / L 140 | D 360 / L 190 | DW47 | + | + |
| | D 163 / L 160 | D 360 / L 210 | DW48 | + | + |
| | D 163 / L 180 | D 360 / L 230 | DW49 | + | + |

► B-box options



| | Ref. | Finish |
|---|--------|--------|
| Hinged door (to be fitted on the right or the left) | DF843 | + |
| Sliding door (to be fitted on the right or the left) | DF853 | + |
| Drawer unit for lateral filing* (front included) <small>* Not compatible with hinged door</small> | BX163 | + |
| Sliding pen tray | BF901K | Grey |



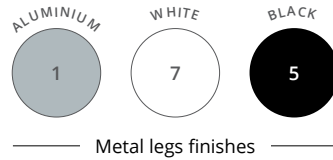

MULTI-WORKSTATIONS
 with Top Access hatch

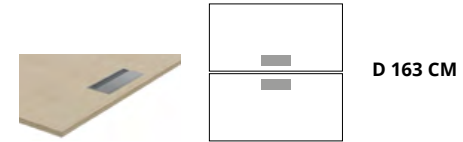

| | | Dim. (cm) | Ref. | Leg finish | Top finish |
|---|--|-----------|------|------------|------------|
| 2 back to back desks D 80 cm Starter unit D 163 / H 72 cm | | L 120 | DE47 | + [] | + [] |
| | | L 140 | DE48 | + [] | + [] |
| | | L 160 | DE49 | + [] | + [] |
| | | L 180 | DE50 | + [] | + [] |
| 2 back to back desks D 80 cm Add-on unit D 163 / H 72 cm | | L 120 | DE51 | + [] | + [] |
| | | L 140 | DE52 | + [] | + [] |
| | | L 160 | DE53 | + [] | + [] |
| | | L 180 | DE54 | + [] | + [] |

COLLABORATIVE DESKS

► **Options**

Double metal cable trays
 D 33,5 / H 9 cm
 Internal H 4,5 cm

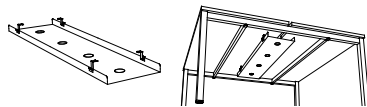

| Dim. (cm) | Ref. |
|----------------------|--------|
| L 75 for L 120 desk | DZ135G |
| L 95 for L 140 desk | DW765G |
| L 115 for L 160 desk | DW775G |
| L 135 for L 180 desk | DW785G |

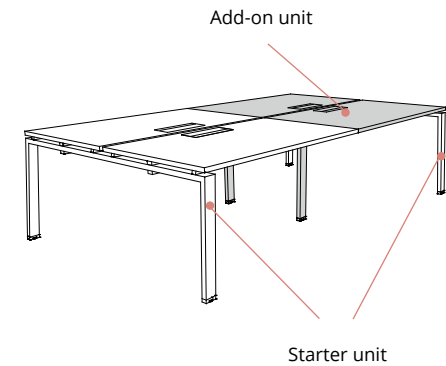

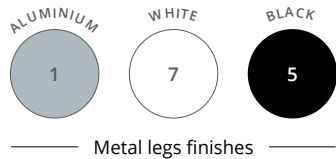

ASTRO



MULTI-WORKSTATIONS with Top Access hatch on B-box consoles

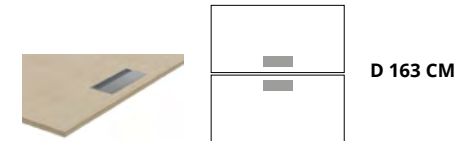

| | Main station dim. (cm) | Total dim. (cm) | Ref. | Leg finish | Top and B-box finish |
|---|------------------------|-----------------|------|------------|----------------------|
| 2 back to back desks D 80 cm on 2 B-box consoles H 72 cm | D 163 / L 140 | D 360 / L 190 | DW56 | + | + |
| | D 163 / L 160 | D 360 / L 210 | DW57 | + | + |
| | D 163 / L 180 | D 360 / L 230 | DW58 | + | + |

► B-box options



| | Ref. | Finish |
|---|--------|--------|
| Hinged door (to be fitted on the right or the left) | DF843 | + |
| Sliding door (to be fitted on the right or the left) | DF853 | + |
| Drawer unit for lateral filing* (front included) <small>* Not compatible with hinged door</small> | BX163 | + |
| Sliding pen tray | BF901K | Grey |

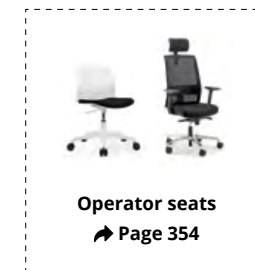

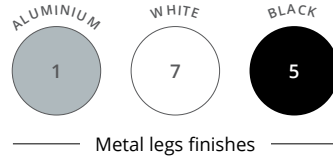

Barrel MEETING TABLES

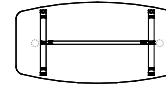

WITHOUT TOP ACCESS HATCH

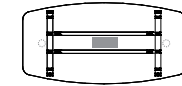

DOUBLE OPENING TOP ACCESS HATCH

| | Ref. | Leg finish | Top finish | | Ref. | Leg finish | Top finish |
|--|------|------------|------------|---|------|------------|------------|
| Barrel tables (seats 6) D 100 / L 200 / H 72 cm D 80 cm legs Top fitted with 2 part drilled cable ports L 140 cm structure | | + | _ | + | _ | + | _ |
| | | | | | | | |

Rectangular MEETING TABLES

The rectangular tables are composed of multiple tops which will not have continuity of grain when placed next to each other.

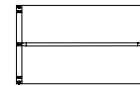

L 140

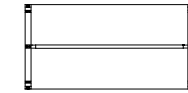

L 200

| | Ref. | Leg finish | Top finish | | Ref. | Leg finish | Top finish |
|--|------|------------|------------|---|------|------------|------------|
| Rectangular tables Starter unit D 100 / H 72 cm D 100 cm legs | | + | _ | + | _ | + | _ |
| | | | | | | | |
| Rectangular tables Add-on unit* D 100 / H 72 cm D 100 cm legs | | + | _ | + | _ | + | _ |
| | | | | | | | |

* Not available in Cedar top

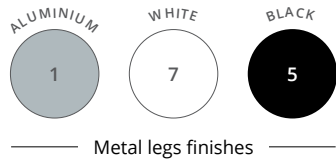

ASTRO



Square MEETING TABLES

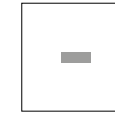

WITHOUT TOP ACCESS HATCH

DOUBLE OPENING TOP ACCESS HATCH

| | Dim. (cm) | | Ref. | Leg finish | Top finish | | Ref. | Leg finish | Top finish |
|--|------------------------------|--|------|------------|------------|--|------|------------|------------|
| Square tables Starter unit H 72 cm | D 143 / L 140 (seats 4/6) | | BZ73 | + | + | | DQ35 | + | + |
| | D 163 / L 160 (seats 6/8) | | BU76 | + | + | | DQ36 | + | + |
| Square tables Add-on unit* H 72 cm | D 143 / L 140 (seats 4) | | BZ75 | + | + | | DQ37 | + | + |
| | D 163 / L 160 (seats 4) | | BU77 | + | + | | DQ38 | + | + |

* Not available in Cedar top

► Options

| | Description | ALUMINIUM Ref. | WHITE Ref. | BLACK Ref. |
|---|--|-------------------|------------------|------------------|
| Vertical cable channel Magnetic | H 61 / L 7 / D 3 | BM291K | BM297S | BM295G |
| Technical metal cable trays D 16 / H 8 cm Internal H 4 cm | L 110 for L 140 desk L 130 for L 160 desk | AZ211K AZ221K | AZ217S AZ227S | AZ215G AZ225G |
| Universal cable duct 4 rings. To be fixed under the top. Screws not supplied | D 6,5 / H 4,5 / L 9,5 | DQ101K | — | — |

How to order ? Square meeting table, with double opening Top Access hatch, D 143 / L 140 cm, starter unit, **Black** metal leg, **Clay** top MFC finish = DQ35 + **5** **X**