

NEW

## **ALTO** Storage solutions

The Alto modular and design storage solutions offer functionality and contemporary design.

With the same esthetics as the **Alto** range, the **Alto** bookcases and credenza complement the layout of workspaces with storage solutions offering practical, functional and smart proximity storage and space partitioning.

With a choice of metal legs (H 32,5 cm) or feet, the **Alto** storage range offers a choice of heights (75, 105, 146, 176 cm) combined with a 100 cm width shared between an open bookcase and a storage with a hinged door.





**Storage with hinged door H 105 cm  
with metal legs**  
Black - Nebraska

**2 storages with hinged door (1 RH door / 1 LH door)  
H 146 cm with screw feet**  
Black - White



STORAGE





# ALTO

WARRANTY  
**10**  
YEARS

## Structure

Storage made of Structorex® melamine-coated panels, 16 mm thick for structure, doors, shelves and 25 mm thick for top and bottom. 2 mm thick shock-proof ABS edging.

## Hinged doors

Hinged doors equipped with 100° opening metal hinges with a soft close system. Black metal design handle.

## Shelves

Shelves made of 16 mm thick Structorex® melamine-coated panels, adjustable in steps of 32 mm.

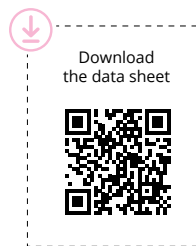

## CHARACTERISTICS

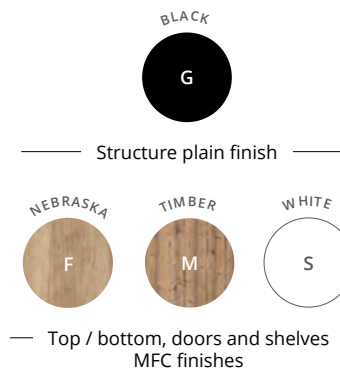

Storage with hinged door  
H 176 / 146 cm



Storage with hinged door  
H 105 / 75 cm

## Legs

Storage available on 4 metal legs or on 5 screw feet.



Credenza with 2 hinged doors  
H 75 cm

## Hinged doors

H 75 cm credenza with push-latch system for easy opening of the doors.

## TECHNICAL DESCRIPTION

- Storage made of Structorex® melamine-coated panels, 16 mm thick for structure, doors, shelves and 25 mm thick with rounded corners for top and bottom. 2 mm thick shock-proof ABS edging.
- 2 base versions to compensate for any unevenness in the floor and allow adjacent units to be aligned.
  - 4 legs H 32,5 cm. Black metal finish, cross-section 25 x 25 mm.
  - 5 screw feet H 25 mm except for H 143,5 storage.
- Storage compartment and hinged door kit positioned (right or left versions) on install.
- Hinged doors equipped with 100° opening metal hinges with a soft close system. Hinged doors have a 3-point locking system (1 point for H 75 cm 2 doors storage unit). The lock comes with an interchangeable cylinder and is supplied with 2 keys, one folding.
- Black metal design handle as standard.
- Shelves made of 16 mm thick Structorex® melamine-coated panels, adjustable in steps of 32 mm on 5 positions. Tool-free shelf installation thanks to pre-drilled cabinet sides. Internal sizes : D 36,5 x L 56,8 / 38 cm for the L 100 cm bookcase and D 34,5 x L 50,5 / 28 cm for the credenza L 143,5 cm.

## H 75 / H 105 cm storage with hinged door

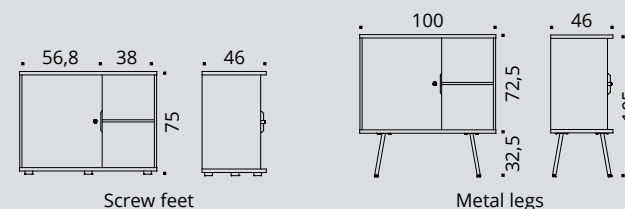

## H 146 / 176 cm storage with hinged door

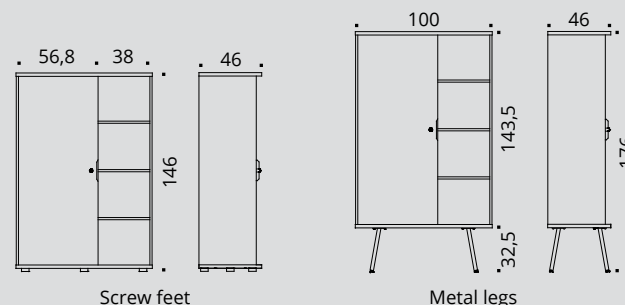

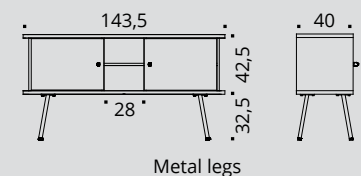

## H 75 cm credenza with 2 hinged doors



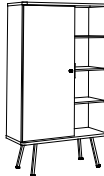
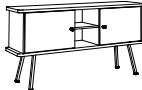

## STORAGE with hinged doors

NEW

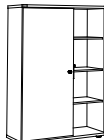
Metal legs		Dim. (cm)	Ref.	Top / bottom + doors + shelves finish
<b>Storage with hinged door</b> <b>H 105 cm</b> 1 Structurex® shelf		D 46 cm / L 100 cm	DY305G	+ <input type="checkbox"/> <input type="checkbox"/>
<b>Storage with hinged door</b> <b>H 176 cm</b> 3 Structurex® shelves		D 46 cm / L 100 cm	DY285G	+ <input type="checkbox"/> <input type="checkbox"/>
<b>Credenza with 2 hinged doors</b> <b>H 75 cm</b> 1 Structurex® shelf		D 40 cm / L 143,5 cm	DY315G	+ <input type="checkbox"/> <input type="checkbox"/>
Screw feet		Dim. (cm)	Ref.	Top / bottom + doors + shelves finish
<b>Storage with hinged door</b> <b>H 75 cm</b> 1 Structurex® shelf		D 46 cm / L 100 cm	DY29G	+ <input type="checkbox"/> <input type="checkbox"/>
<b>Storage with hinged door</b> <b>H 146 cm</b> 3 Structurex® shelves		D 46 cm / L 100 cm	DY27G	+ <input type="checkbox"/> <input type="checkbox"/>

